



Features

- Input Voltage: AC 100-270V
- LED Source: Cree
- PF: >0.95
- CRI: >75 Ra
- IP Rating: IP66
- Lumen Flux: 120 Lm/w
- Anti-Corrosion: WF2
- Weight: 3.8 kg / 8.3 lbs
- Ex-Proof Grade: Ex d IIC T6

Models Available

MODEL	WATTAGE
2M-EXI8189-40	40W
2M-EXI8189-60	60W
2M-EXI8189-70	70W

Dimensions

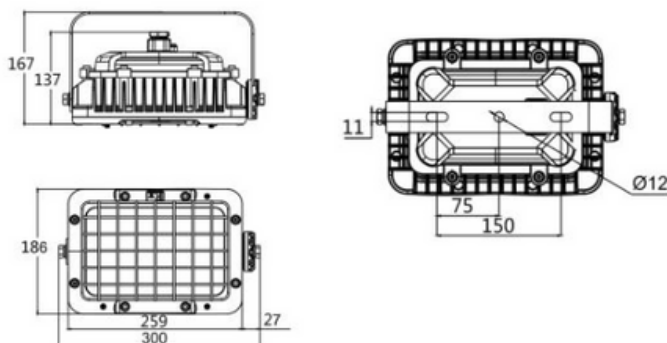

Specifications

GENERAL SPECIFICATIONS

Rated Voltage	AC 220V
Power	60W
Frequency	50/60 Hz
Light Efficiency	120 lm
Power Factor	>0.95 PF
Operating Temperature	-30~50°C / -22~122°F
Storage Temperature	-30~50°C / -22~122°F
Protection Level	IP66
Lighting Angle	15/25/36/45/60/90/120°
Light Source	LED
Correlate Color Temperature	3000-6500 K
Color Rendering Index	≥70 Ra
LED Quantity	95 pcs
Base Specifications	CREE3030
LED's Operating Life	100,000 hrs
Start-Up Time	≤0.2 s
Anti-Corrosion Grade	WF2
Explosion-Proof Grade	Ex d e mb IIC B T6
Executive Standard	GB3836.1 / GB3836.2
Weight	3.8 kg / 8.3 lbs
Size	300 x 186 x 137 mm / 11.8" x 7.3" x 5.3" in
Packaging Size	25 x 25 x 22.3 cm / 9.8" x 9.8" x 8.8" in
Gross Weight	5 kg / 11 lbs

Light Distribution

