

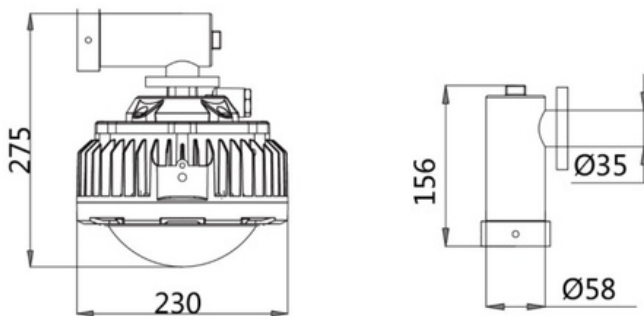

Features

- Configuration: LED light source, the average service life is as long as 100,000 hours. The power supply uses a wide voltage processing, which can realize constant current output, has short circuit and over voltage protection functions, and greatly prolongs the service life of lamps and lanterns.
- Heat Dissipation: The radiator adopts an integrated streamlined structure, which can better increase heat conduction. The radiator is arranged in an internal and external circular array to improve its heat dissipation performance.
- Anti-Glare: Toughened glass cover (options: transparent or frosted) anti-impact, uniform lighting to minimize shadows. Light transmittance up to 95-98%, suitable for various low-roof, platform, high roofs, and other places as fixed lighting.
- Protection: IP66 protection level, corrosion protection level can reach WF2, the surface of the lamp body will never corrode, never rust.
- Installation Mode: It can adopt many kinds of installation modes such as law fence street lamp and guardrail street lamp according to the needs.

Dimensions



Specifications

GENERAL SPECIFICATIONS	
Rated Voltage	AC 220V
Power	80W
Protection Level	IP66
Light Angle	120°
LED Quantity	80 pcs
Base Specifications	CREE3030
Anti-Corrosion Grade	WF2
Explosion-Proof Grade	Ex d IIC T6
Light Efficiency	120 lm/W
Frequency	50/60 Hz
Power Factor	>0.95 PF
Storage Temperature	-30~50°C / -22~122°F
Light Source	LED
Correlate Color Temperature	3000-6500 K
Color Rendering Index	≥70 Ra
LED's Operating Life	100,000 hrs
Start-Up Time	≤0.2 s
Weight	7.6 kg / 16.8 lbs
Size (Dia. x H)	Ø 230 x 275 mm / Ø 9" x 10.8" in

Models Available

MODEL	WATTAGE
2M-EX08231-50	50W
2M-EX08231-60	60W
2M-EX08231-80	80W
2M-EX08231-90	90W

Light Distribution

